

International Journal of Innovative Research in Science, Engineering and Technology

(An ISO 3297: 2007 Certified Organization)

Website: www.ijirset.com

Vol. 6, Issue 6, June 2017

Occupational Safety and Health Improvement at Casting Plant

V.Vasanthakannan¹, M.Murugan², K.Vijay Babu³

First Year PG Student, Excel College of Engineering and Technology, Komarapalayam, Tamilnadu, India¹,

Professor, Excel College of Engineering and Technology, Komarapalayam, Tamilnadu, India²,

Associate Professor, Excel College of Engineering and Technology, Komarapalayam, Tamilnadu, India³

ABSTRACT: Occupational safety and health issues among workers are gaining prominence in industrial sectors. To ensure that all workers are free from any hazards, preventive actions should be given priority. These hazards can cause accidents and ill health to the workers due to unsafe conditions or unsafe act. This project was carried out at a casting plant. The project have identified the hazard, assess the risk and proposed control measures. Three methods are used to collect data which are questionnaires, interviews and observations. Process with high risk is pouring process due to manual lifting and carrying molten metal. The hot environment cause heat stress, and sand dust can cause silicosis. Trolley was designed to eliminate the need to carry the molten metal during pouring. Finite element analysis was carried out to study the strength of material and suitability of the design. A ventilation system was proposed to reduce the effect of heat stress and mineral dust from the greensand mould. Engineering analysis was carried out during the design of the ventilation system.

KEYWORDS : Occupational Safety and Health Act 1994 (OSHA), Factory and Machinery Acts 1967 (FMA), Hazard Identification, Risk Assessment, and Risk Control (HIRARC).

I. INTRODUCTION

Safety and health has become major issues of every workplace. Industry, government, the public and academia has taken significant interest and put pressure on employers about the importance of safety and health to employees. Both employers and employees must comply with the Occupational Safety and Health Act 1994 and its regulations to avoid risk and accidents in workplace. Safety is vague because to some extent safety is a value judgment, but precise because in many cases, one can readily distinguish a safe design from an unsafe one. The American Heritage Dictionary defines safety as freedom from damage, injury or risk. The Oxford Dictionary defines health as the state of being well, having or showing or producing or functioning well, beneficial and good. Many workers become seriously ill as a result of unsafe and unhealthy working conditions. Occupational accidents are common occurrence. The number of reported accidents has increased sharply in countries where industrial development has been rapid or where reporting systems for accidents have improved. Accident rates remain particularly high in hazardous industries such as manufacturing, mining, construction and forestry. There is a growing awareness too, of the close relationship between working conditions and productivity. The improvement of occupational safety and health is considered an important prerequisite for economic and social development. In response, most governments have taken steps to review policy and legislation. Employers and workers are becoming increasingly aware that safe and healthy working conditions are essential for sustainable growth. It is important to realize that health and safety problems must be solved through the commitment of all concerned. Technical solutions alone cannot lead to concrete improvement. The purpose of this project is to suggest improvement in safety and health at a casting plant. The plant is a ferrous and non-ferrous foundry, and produce variety of casting products. The company has many processes which have safety and health hazards. It is important to implement safety and health policy and program to protect workers. This study will focus on health and safety improvement at the casting plant.

International Journal of Innovative Research in Science, Engineering and Technology

(An ISO 3297: 2007 Certified Organization)

Website: www.ijirset.com

Vol. 6, Issue 6, June 2017

1.1 Methodology

The methodology in this research is shown in Figure 1

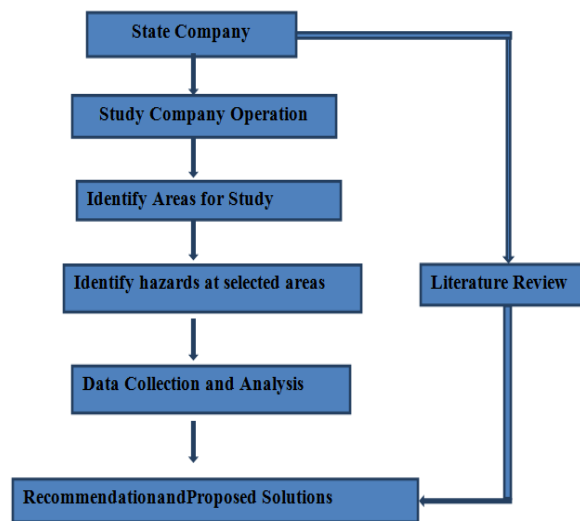

Figure.1 Project methodology

1.2 Likelihood of an Occurrence

This value is based on the likelihood of an event occurring. Assessing likelihood is based on worker experience, analysis or measurement. Likelihood levels range from “most likely” to “inconceivable.” For example, a small spill of bleach from a container when filling a spray bottle is most likely to occur during every shift. Alternatively, a leak of diesel fuel from a secure holding tank may be less probable.

Likelihood	Example	Rating
Most likely	The most likely result of the hazard/event being realized	5
Possible	Has a good chance of occurring and is not unusual	4
Conceivable	Might occur at some time in the future	3
Remote	Has not been known to occur after many years	2
Inconceivable	Is practically impossible and has never occurred	1

Table.1 Likelihood of an occurrence

1.3 Severity of Hazard

Severity can be divided into five categories. Severity is based upon an increasing level of severity to an individual’s health, the environment, or to property.

International Journal of Innovative Research in Science, Engineering and Technology

(An ISO 3297: 2007 Certified Organization)

Website: www.ijirset.com

Vol. 6, Issue 6, June 2017

Everity(s)	Example	Rating
Catastrophic	Numerous fatalities,irrecoverable property damage and productivity	5
Fatal	Approximately one single fatality or major property damage if hazard is realized	4
Serious	Non-fatal injury,permanent disability	3
Minor	Disabling but not permanent injury	2
Negligible	Minor abrasions,bruises,cuts, first aidtype injury	1

Table.2 Severity of hazard

1.4 Risk Assessment

Risk assessment is an overall process of estimation the magnitude of risk and deciding whether or not the risk is tolerable. Risk can be presented in variety of ways to communicate the results of analysis to make decision on risk control. For risk analysis that uses likelihood and severity in qualitative method, presenting result in a risk matrix is a very effective way of communicating the distribution of the risk throughout a plant and area in a workplace as shown in Table 2.2.

Risk can be calculated using the following formula:

$$L \times S = \text{Relative Risk}$$

L = Likelihood

S = Severity

Likelihood (L)	Severity (S)				
	1	2	3	4	5
5	5	10	15	20	25
4	4	8	12	16	20
3	3	6	9	12	15
2	2	4	6	8	10
1	1	2	3	4	5

Table.3 Risk matrix

To use this matrix, first find the severity column that best describes the outcome of risk. Then follow the likelihood row to find the description that best suits the likelihood that the severity will occur. The risk level is given in the box where the row and column meet. The relative risk value can be used to prioritize necessary actions to effectively manage work place hazards. Table 2.3 determines priority based on the following ranges

International Journal of Innovative Research in Science, Engineering and Technology

(An ISO 3297: 2007 Certified Organization)

Website: www.ijirset.com

Vol. 6, Issue 6, June 2017

RISK	DESCRIPTION	ACTION
15 - 25	HIGH	A HIGH risk requires immediate action to control the hazard as detailed in the hierarchy of control. Actions taken must be documented on the risk assessment form including date for completion.
5 - 12	MEDIUM	A MEDIUM risk requires a planned approach to controlling the hazard and applies temporary measure if required. Actions taken must be documented on the risk assessment form including date for completion.
1 - 4	LOW	A risk identified as LOW may be considered as acceptable and further reduction may not be necessary. However, if the risk can be resolved quickly and efficiently, control measures should be implemented and recorded.

Table.4 Risk level from risk matrix

1.5.Sand Casting Process

The outline of production steps in a typical sand casting operation. The main generic processes in foundries are listed below;

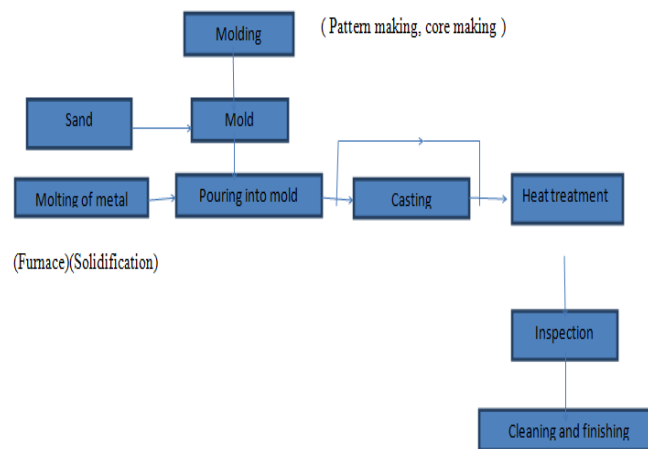

Figure.2 Outline of production steps in a typical sand casting operation

- Pattern/tool making
- Mould preparation
- Metal preparation
- Metal melting
- Casting
- Removal of castings
- Fettling and finishing
- Heat treatment
- Material handling and packaging.

1.6. Potential health risk in foundries

The potential health risk in foundries are listed below;

- Occupational overuse syndrome (OOS)
- Cancer
- Dermatitis
- Stress

International Journal of Innovative Research in Science, Engineering and Technology

(An ISO 3297: 2007 Certified Organization)

Website: www.ijirset.com

Vol. 6, Issue 6, June 2017

- v. Fatigue
- vi. Metal fume fever
- vii. Vibration white finger
- viii. Burns
- ix. Soft tissue injuries
- x. Lead poisoning
- xi. Respiratory disease
- xii. Sprains and strains
- xiii. Back injuries
- xiv. Eye injuries
- xv. Silicosis
- xvi. Noise-induced hearing loss

1.7. Methods to Control Workplace Hazards

- i) Elimination
- ii) Substitution
- iii) Engineering Controls
 - a) Enclosure
 - b) Isolation
 - c) Ventilation
- iv) Administrative Controls
- v) Personal Protective Equipment

II. METHODOLOGY

2.1 Introduction

This chapter discuss on the methodology to collect and analyze data to identify hazards and proposed control measures. The study focus on safety and health hazards in the casting area.

2.2 Justification for the Methodology

In identifying the safety and health hazards, a few methods are used. The methods are:

- i. Questionnaire survey of the workers
- ii. Interviews with the workers and management
- iii. Observation and discussion
- iv. Information from the company

2.3 Research Procedures

2.3.1 Data Analysis

The primary method used for data analysis is the survey. Questionnaires were distributed to 33 workers, (30 male and 3 female) at casting plant. The questionnaires listed questions on hazards in the casting plant. The workers are exposed to various hazards at any workstation in the casting plant and they can identify safety hazards. In this study, the questionnaire was divided into 6 areas, background of workers, types of accidents, health problem, personal protective equipment, manual handling and heat stress. The main objective is to get information on safety and health hazard among workers at casting plant. Charts will be used to analyze the questionnaire. Once safety and health hazard has been identified, brainstorming and discussion will be held to determine possible solutions to improve safety and health condition at casting plant. The secondary method used for data analysis is by referring to guidelines for hazard identification, risk assessment and risk control (HIRARC). The purpose of this guideline is to provide a systematic and objective approach to assessing hazards and their associated risks to provide an objective measure of identified hazards as well as to provide methods to control risk.

International Journal of Innovative Research in Science, Engineering and Technology

(An ISO 3297: 2007 Certified Organization)

Website: www.ijirset.com

Vol. 6, Issue 6, June 2017

2.3.2 Planning and Conducting HIRARC

The purpose of HIRARC is to identify all factors that can cause harm to employees.

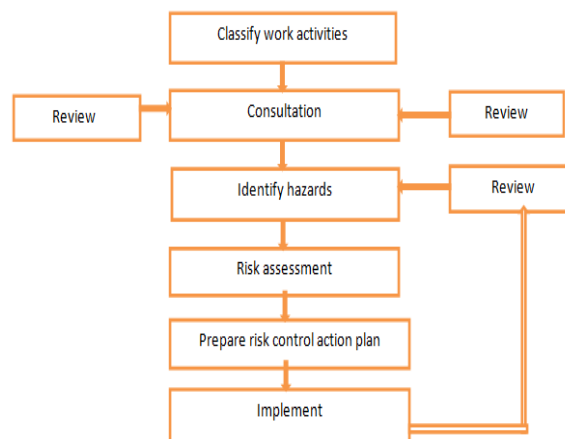

Figure.3 Flowchart of HIRARC process.

HIRARC process requires four simple steps;

- a) Classify work activities
- b) Identify hazard
- c) Conduct risk assessment (analyze and estimate risk from each hazard), by calculating or estimating:
 - i. Likelihood of occurrence
 - ii. Severity of hazard
- d) Decide if risk is tolerable and apply control measures (if necessary).

2.3.3 Risk Analysis

This objective is to identify safety and health hazard during pouring process at pouring workstation and to determine risk control. The steps to conduct risk analysis are;

- a) Choose the work station to conduct risk analysis. The pouring workstation at casting plant is selected.
- b) Prepare a list of potential hazard for the workstation to be studied. Table 2.1 and Table 2.2 show the severity of hazard and likelihood of occurrences.
- c) Prepare a risk analysis work sheet to record potential hazards.
- d) Carry out analysis.

III. DATA COLLECTION AND ANALYSIS

3.1 Introduction

This chapter discusses data collection and data analysis at casting plant. Data will be analyzed in tables and chart to ease the understanding. After data analysis, safety hazards can be identified and suggestion for improvement can be made.

3.2 Data Collection

Data in this project is obtained from questionnaires that been given to the workers and interview with management. Some information is gathered by observation. Background of casting plant where this case study was carried out is explained.

3.2.1.1 Casting plant Organization

Figure.4 shows the organization chart of casting plant. The company has two main departments, administration and production department. Production at casting plant has two sections; factory and foundry. Each department is managed by one manager. Each manager reports to the managing director. This project will focus on foundry section. The foundry section has 33 personnel, 30 male and 3 female staffs.

International Journal of Innovative Research in Science, Engineering and Technology

(An ISO 3297: 2007 Certified Organization)

Website: www.ijirset.com

Vol. 6, Issue 6, June 2017

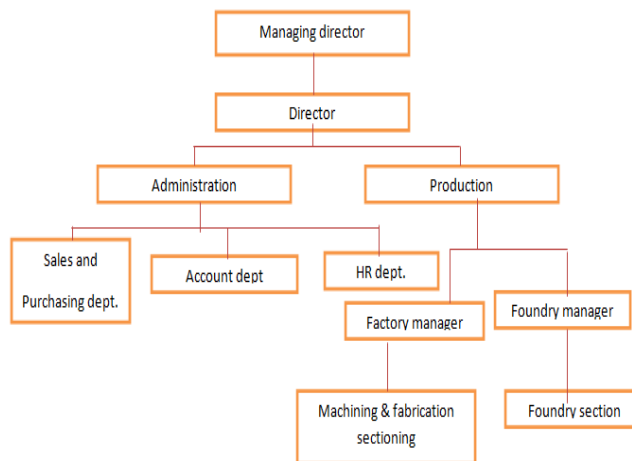

Figure.4 Organization chart at casting plant

3.2.1.2 Casting Plant Layout

The total land area of this company is 40,000 square feet. The foundry area 25,150square feet and the rest is fabrication area.

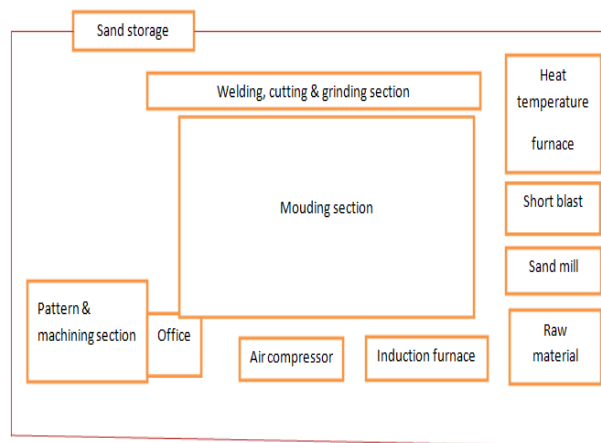

Figure.5 Foundry layout

3.2.1.3 Process Flow Chart of Casting Plant

Figure.6 shows the process flowchart for casting at casting plant. In casting plant has three main activities; pattern making, prepare mold and core and pouring process. In the sand casting process, pattern is made in the shape of the desired part. The pattern is typically made of wood, plastic, or metal. Basically, sand casting operations use silica sand (SiO_2) as mold material and making core. In sand mixing machine, sand is mixed together with sodium silicate for mould making and core. CO_2 are using to harden the mold and core. Next, the mold must be coated and dried before pouring molten metal into mold. Coating is to avoid air and moisture trapped in the mold. Molten material is poured in the pouring cup, which is part of the gating system that supplies molten material to the mold cavity. After solidification, the casting is shaken out of its mold, and the sand and oxide layers adhering to the casting are removed by sand blasting. Casting product is cleaned by blasting with steel shot.

International Journal of Innovative Research in Science, Engineering and Technology

(An ISO 3297: 2007 Certified Organization)

Website: www.ijirset.com

Vol. 6, Issue 6, June 2017

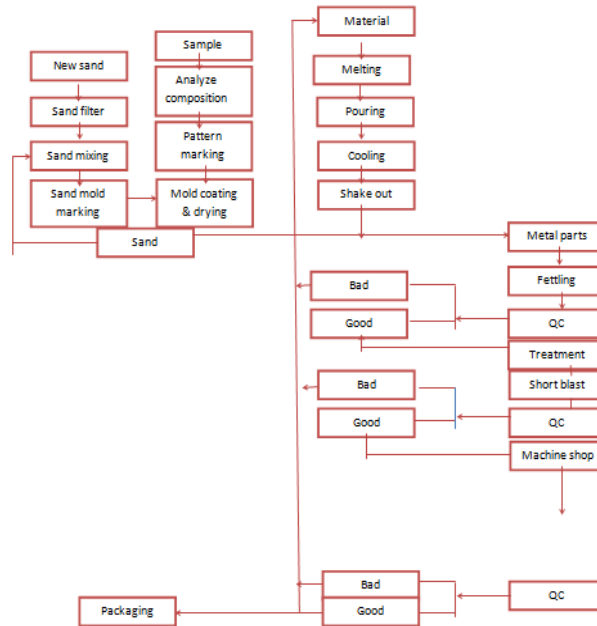

Figure.6 Casting process flowcharts

3.2.2 Casting Plant Safety Report

Casting plant safety report shows accident record from January 2000 until October 2009, data of medical certificate and accident data in 2009.

3.2.3 Indoor Air Quality (IAQ) Monitor

Indoor air quality equipment, are used for monitoring indoor air environment such as temperature, humidity, gases including carbon dioxide, ammonia, carbon monoxide, and chlorine. IAQ monitor are used at buildings that are served by a common ventilation and/or air conditioning system. Figure .7 shows the layout of the pouring area. The IAQ measurement data was taken based on the layout. The pouring area are divided into two sections; pouring process with 64 points and furnace with 24 points. The data for one location at pouring process was taken three times in two minutes duration and distance point to point is 5 feet (y-axis) and 4.5feet (x-axis). The data for one location at the furnace was taken three times in two minutes duration and distance point to point is 3.5 feet (y-axis) and 4feet (x-axis).

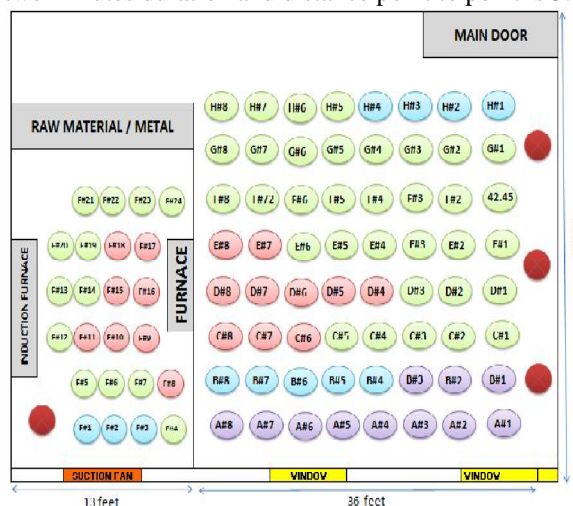

Figure.7 Layout of pouring area.

International Journal of Innovative Research in Science, Engineering and Technology

(An ISO 3297: 2007 Certified Organization)

Website: www.ijirset.com

Vol. 6, Issue 6, June 2017

3.2.4 Questionnaires

There are 25 questions in the questionnaire form. Thirty-three forms were distributed to all workers in all departments. The questionnaires are categorized in three categories, workbackground, workplace environment and work safety. All feedbacks from the questionnaire will be discussed in data analysis.

3.3 Data Analysis

3.3.1 Workplace Environment

Workplace environment is the second questionnaire. There have Seven types of hazards are asked: back injury, hot environment, dust, poor ventilation, lighting, noise and chemical hazard. All data from questionnaire are analyzed and summarized in Table .5. Back injury is main problem because they need to lift and carry heavy object such as the mould. The second problem is hot environment especially at pouring process and furnace, followed by dust and poor ventilation. Other problems are lighting, noise and chemical hazard.

Problems	Number of workers (33 workers)	Number of workers(in percentage)
Back injury	30	90.91%
Hot environment	27	81.82%
Dust	25	75.76%
Poor Ventilation	18	54.55%
Lighting	10	30.30%
Noise	5	15.15%
Chemical Hazards		9.09%

Table.5 Types of problem

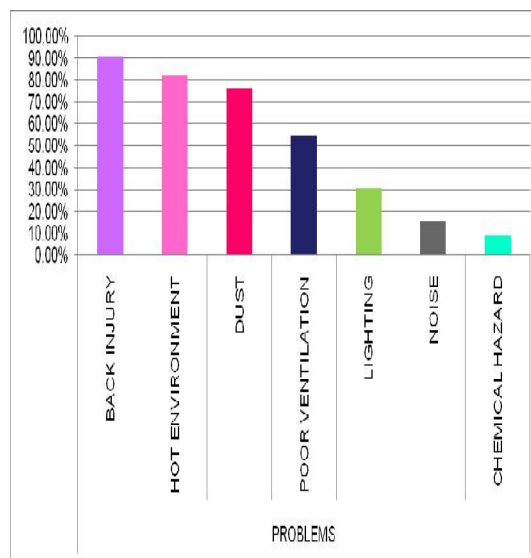

Figure.8 Pareto diagram on types of problem

Table shows the number of injuries by job categories. There are seven job categories which are hot metal works, mold making, shakeout, sand casting, core makers and grinders. Mostly accident occurs at hot metal works and mold making.

International Journal of Innovative Research in Science, Engineering and Technology

(An ISO 3297: 2007 Certified Organization)

Website: www.ijirset.com

Vol. 6, Issue 6, June 2017

Job categories (Accident/Injury)	Number of workers (33 workers)
Hot Metal Work	17
Molders	13
Coating	8
Shake Out	7
Sand Blasting	6
Coremakers	4
Grinders	4
Pattern Makers	2
Heat Treatment	1

Table.6 Number of injuries by job categories

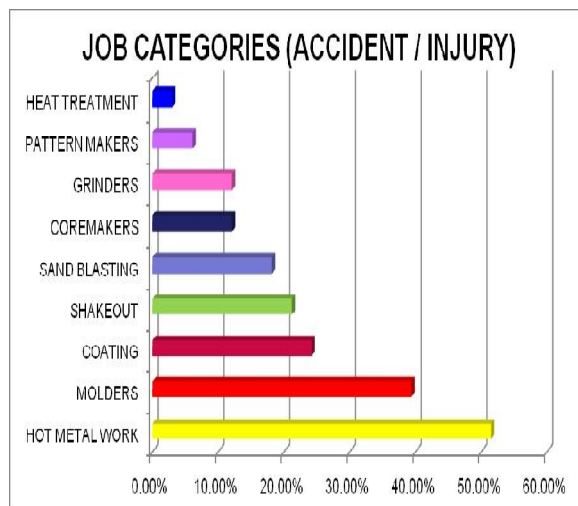

Figure.9 Pareto diagram for number of injuries by job categories

Workplace environment is the second categories in the questionnaire. There were seven types of health hazards which are back injury, hot environment, dust, poor ventilation, lighting, noise and chemical hazard.

3.3.1.3 Work Safety

Third categories in the questionnaire are work safety and focused on safety hazards and personal protective equipment (PPE). PPE is important to protect workers from any accidents. Table.7 shows seven types of PPE such as safety boots, gloves, goggles, mask, apron, ear protection and face shield. Most workers wear safety boots at the plant.

Table. 8 shows the data for parts of body which are in accidents are injured. There are nine job categories: pattern makers, molders, core makers, coating, hot metal works, shakeout, grinders, sand blasting and heat treatment. Nine parts of body frequently injured are head/hair, face, eye, nose, ear, finger, hand, body and leg. The data shows that most workers obtain have injury at the head, body and hand at hot metal work.

International Journal of Innovative Research in Science, Engineering and Technology

(An ISO 3297: 2007 Certified Organization)

Website: www.ijirset.com

Vol. 6, Issue 6, June 2017

PPE	Number of workers using ppe
Safety Boot	33
Gloves	12
Google's	11
Mask	3
Apron	2
Ear Protection	1
Face Shield	0

Table.7 Number of workers using PPE

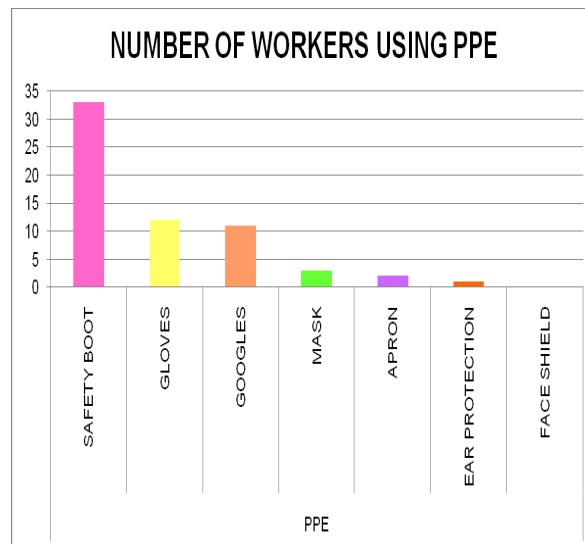

Figure.10 Pareto diagram on the number of worker using PPE

Part of body injured	Number of workers								
	Pattern	Molders	Core makers	Coating	Hot metal work	Shake out	Grinders	Sand blasting	Heat
Head	0	1	0	0	15	1	1	1	1
Face	1	1	1	1	2	5	1	2	0
Eye	1	3	1	1	0	25	0	6	0
Nose	0	4	1	0	0	24	0	4	0
Ear	0	7	1	0	0	15	0	1	0
Finger	1	8	4	6	10	5	2	3	0

International Journal of Innovative Research in Science, Engineering and Technology

(An ISO 3297: 2007 Certified Organization)

Website: www.ijirset.com

Vol. 6, Issue 6, June 2017

Hand	1	1 6	4		15	5	3	5	1
Body	0	4	4	0	15	4	4	0	0
Leg	0	8	4	5	8	2	1	1	0

Table.8 Data for injured body parts

3.4 Problem Identification

After data collection and analysis casting plant has two main hazards.

- i. Working condition not ergonomic which can cause back injury and hand injury due to poor material handling while pouring.
- ii. Poor ventilation which cause employees to be exposed to dust, fume, glare and heat.

3.5 Summary

From data collection and analysis, pouring area has two main hazards which are material handling and ventilation. There is no mechanized material handling to minimize back injury. At pouring area, the workers exposed to dust, fume, glare and extreme heat due to insufficient ventilation.

IV. PROPOSED SOLUTIONS

4.1 Introduction

This chapter discussed proposed solutions to control health hazards at pouring area.

4.2.1.1 Pouring Trolley Design.

Pouring trolley can be used at the casting plant to replace manual pouring.

The material selected for the pouring trolley is carbon steel. The steel has good mechanical properties and cost effective. The dimension of this part is 1000 mm L x 500 mm W x 750 mm H. The height of the trolley is at the waist of the workers according to ISO Std7250, Body Human Measurement. The width of trolley is based on length and width of the mold. The design require a table to place the mold which is 15cm.

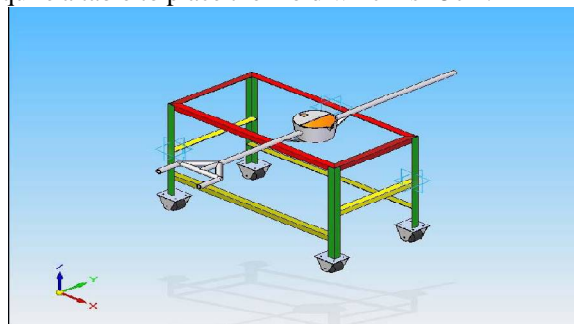

Figure.11 Pouring trolley design

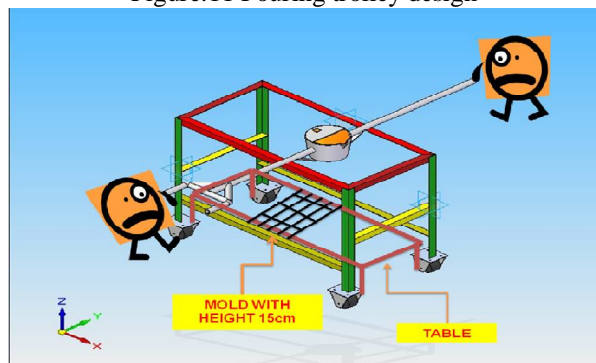

Figure.12 Methods when using pouring trolley.

International Journal of Innovative Research in Science, Engineering and Technology

(An ISO 3297: 2007 Certified Organization)

Website: www.ijirset.com

Vol. 6, Issue 6, June 2017

4.2.1.2 Analysis of Pouring Trolley

The design of the pouring trolley is analyzed using MSC Patran Version 2005. The pouring trolley is analyzed using static analysis. The model consists of carbon steel angle iron 20 mm by 20 mm width and 3 mm thickness. The dimension of the pouring trolley is 1000 mm length and 500 mm width and 750 mm height.

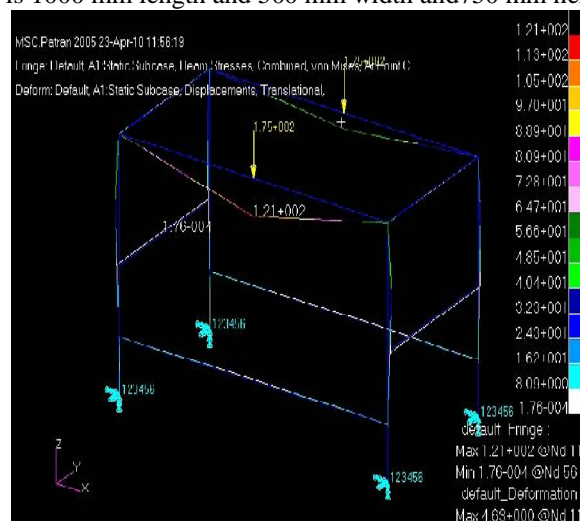

Figure.13 Result of stress analysis of pouring trolley design

Figure.13 shows the stress analysis for the pouring trolley. Load is placed in the middle of the trolley and gradually increased until it reached the point of failure.

4.3 Summary

This chapter has discussed the proposed solutions to reduce hazards at the casting plant. The use of pouring trolley can minimize back pain. The installation of local exhaust ventilation can reduce extreme heat and dust from the sand casting process.

IV. CONCLUSION

This chapter discusses conclusions of this project. The first part summarizes the project and the second part is recommendation for future works.

This project study health hazards at casting plant, namely manual handling and heat stress. This project started with review of the literature, questionnaire survey and observation at the casting plant to identify health hazards. The first objective of the project is to identify health hazards and assess risk and develop control measures. Data collections are done through survey, observation and indoor air temperature measurement, data analysis, two problems were identified which are manual handling and heat stress. Two proposed safety improvements were developed. Pouring trolley was recommended to replace manual pouring to minimize back pain. This pouring trolley can also increase productivity. Local exhaust ventilation was recommended based on Indoor Air Quality Monitor data and analysis. The result showed that the temperature at pouring area is around 43.40°C and a ventilation system is needed to replace the fan and suction fan. Local exhaust ventilation can reduce heat as well as dust. The use of pouring trolley and installation local exhaust ventilation can improve health and safety at the casting plant.

REFERENCES

1. Tycho K. Fredericks, Anil R. Kumar, Sadat Karim, *An Ergonomics Evaluation of a Manual Metal Pouring Operation*, 2008, 182-192.
2. *Guidelines for Hazard Identification, Risk assessment and Risk Control (HIRARC)*, Department of Occupational Safety and Health, Ministry of Human Resources, Malaysia, 2008. JKPP DP 127/789/4-47.

International Journal of Innovative Research in Science, Engineering and Technology

(An ISO 3297: 2007 Certified Organization)

Website: www.ijirset.com

Vol. 6, Issue 6, June 2017

3. Karim, S. Fredericks, *Physiological cost of manual metal pouring operations*. 1998, 29-33.
4. Itasca , National Safety Council (1994), *Accidents Facts*.
5. Farhang A.K and Michael S.B, Comfort of personal protective equipment, *Applied Ergonomics* , Vol.26, 1995,195-198.
6. TasneemAbbasi, S.A. Abbasi, *Dust Explosions- Cases, causes, consequence and control*.
7. Chaffin, D.B, Manual material handling and the biomechanical basis for prevention of low back pain in industry.1987, 989-996.
8. Gettysburg College (February 2, 2007)..*Personal Protective Equipment Program*.
9. Purdue University (February 14, 2003)..*Personal Protective Equipment(PPE) Policy*. 2-5.
10. Breish, S. B, *What is ahead?* , Dec 1989, 48-52.
11. Ames Health and Safety Procedures and Guidelines (2004), *Chapter 33- Personal Protective Equipment (PPE) Hazard Assessment and Selection (REDACTED)*.2-24.
12. T.Myers, Albaretta, *Investigation of the Jahn Foundry and CTA Acoustics dust explosions: similarities and differences* , 2009,1-6